

Montageanleitung
Arbeitsscheinwerfer

Mounting Instructions
Work lamps

Instructions de montage
Projecteur de travail

Monteringsanvisning
Arbetsstrålkastare

Montagehandleiding
Werklamp

Instrucciones de montaje
Faro de trabajo

Istruzioni di montaggio
Faro de lavoro

Asennusohje
Työvaloneheitintä

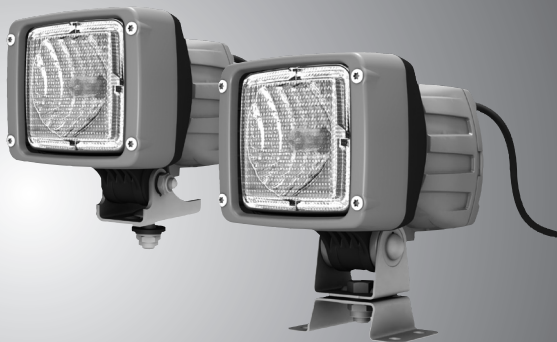

Ultra Beam X-Powerpack





Produkthaftung

- Es sind die nationalen Anbau-, Einbau- und Betriebsvorschriften zu beachten und einzuhalten.
- Lesen Sie bitte vor Gebrauch des Gerätes alle beigelegten Anleitungen und Sicherheitshinweise.
- Im Zuge von Produktverbesserung behalten wir uns technische und optische Änderungen vor.
- Verwenden Sie nur die Originalersatzteile bzw. nur Ersatzteile die von HELLA freigegeben sind.
- Bei Fragen oder Einbauproblemen, rufen Sie den HELLA Kundendienst, Großhändler oder wenden Sie sich an Ihre Vertragswerkstatt.

Product liability

- National mounting, fitting and operating regulations must be heeded and kept.
- Please read all the instructions and safety notes included before using the device.
- We reserve the right to make technical and optical modifications within the course of product improvement.
- Only use original spare parts or spare parts approved by HELLA.
- If you have any questions or installation problems, call HELLA customer services, your wholesaler or contact your specialist garage.

Responsabilité produit

- Les prescriptions nationales en matière de montage et de service doivent être observées et respectées.
- Avant d'utiliser l'appareil lire toutes les instructions de montage et de service fournies ainsi que les conseils de sécurité.
- Dans le cadre de l'amélioration continue de nos produits, nous nous réservons le droit de réaliser des modifications sur les plans technique et optique.
- Utilisez uniquement des pièces d'origine ou des pièces de rechange validées par HELLA.
- Pour tous renseignements ou problèmes de montage, contactez le S.A.V. HELLA, votre distributeur ou votre garage lié par contrat.

Produktansvar

- De nationella monterings-, installations- och driftföreskrifterna ska beaktas och följas.
- Läs alla medföljande instruktioner och säkerhetsanvisningar innan du använder apparaten.
- Vi förbehåller oss rätten till tekniska och optiska ändringar som förbättrar produkten.
- Använd endast original reservdelar resp. endast reservdelar som har godkänts av HELLA.
- Om du har frågor eller problem med installationen, ring HELLA kundtjänst, partihandlaren eller vänd dig till din märkesverkstad.

Productaansprakelijkheid

- Men dient de nationale aanbouw-, inbouw- en bedrijfsvoorschriften in acht te nemen en na te leven.
- Lees a.u.b. alvorens het apparaat te gebruiken alle bijgevoegde gebruiksaanwijzingen en veiligheidsinstructies door.
- In het kader van de productverbetering behouden wij ons technische en optische veranderingen voor.
- Gebruik uitsluitend de originele reserveonderdelen, die door Hella vrijgegeven zijn.
- Bij vragen of inbouwproblemen dient u de HELLA klantenservice, de groothandel te bellen of u te richten tot de dealerwerkplaats.

Responsabilidad civil por productos defectuosos

- Tienen que observarse y cumplirse con las prescripciones nacionales sobre construcciones anexas, de montaje y de funcionamiento
- Rogamos que antes de usar el aparato lean todas las instrucciones y advertencias sobre la seguridad adjuntas.
- En aras de la mejora de los productos, nos reservamos el derecho de hacer modificaciones técnicas y ópticas.
- Use sólo recambios originales o bien sólo recambios autorizados por HELLA.
- Si tiene preguntas que hacemos o dificultades en el montaje, llame al Servicio de Atención al Cliente de HELLA, a los mayoristas o dirijase a su taller concesionario.

Responsabilità per il prodotto

- si devono rispettare tutte le normative nazionali di attacco, montaggio e funzionamento.
- Prima di usare l'apparecchio, legga per favore tutte le istruzioni e le avvertenze di sicurezza allegate.
- Nell'ambito del perfezionamento del prodotto, ci riserviamo modifiche tecniche ed estetiche.
- Utilizzare solo pezzi di ricambio originali risp. pezzi autorizzati dalla HELLA.
- In caso di domande o problemi di montaggio, chiami il servizio di assistenza dei clienti della HELLA, il rivenditore o si rivolga alla Sua officina autorizzata.

Tuotevastuu

- Kansalliset asennus- ja käyttöohjeet on huomioitava ja niitä on noudatettava. Lue ennen laitteen käyttöä kaikki oheiset käyttö- sekä turvaohjeet.
- Jatkuvasta tuotekehittälestä johtuen pidätämme oikeuden teknisiin ja optisiin muutoksiin.
- Käytä vain alkuperäisiä tai HELLAN hyväksymiä varaosia.
- Jos Sinulla on kysymyksiä tai asennusongelmia, soita HELLA asiakaspalveluun, tukkukauppiaille tai käänny sopimuskorjaamon puoleen.

Benötigtas Werkzeug
Tools required
Outilsage nécessaire

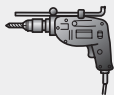

Nödvändiga verktyg
Noodzakelijk gereedschap
Herramientas necesarias

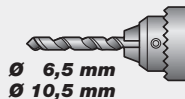

Utensili necessari
Tarvittavat työkalut

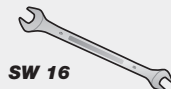

4

Montage
Mounting
Montage

Montering
Montage
Montaje

Montaggio
Suora

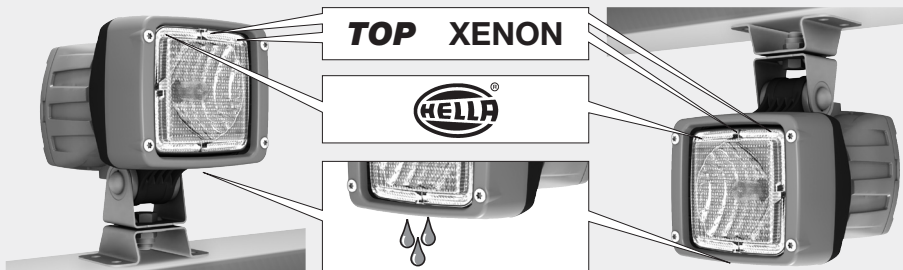

Lieferumfang / Montage
Kit includes / Mounting
Fourniture / Montage

Leveransomfattning / Montering
Inhoud set / Montage
Volumen del suministro / Montaje

Dotazione die fornitura / Montaggio
Osaluettelo / Suora

5

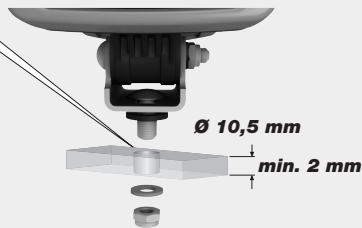
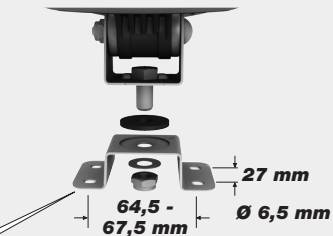
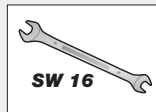
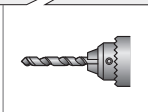

Lampentausch
Changing the bulb
Remplacement de la lampe

Lampbyte
Verwisselen gloeilamp
Cambio de lámparas

Sostituzione lampadina
Poittimon vaihto

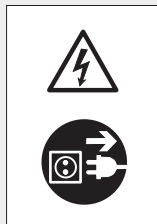
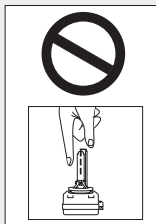

6

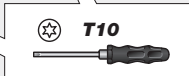
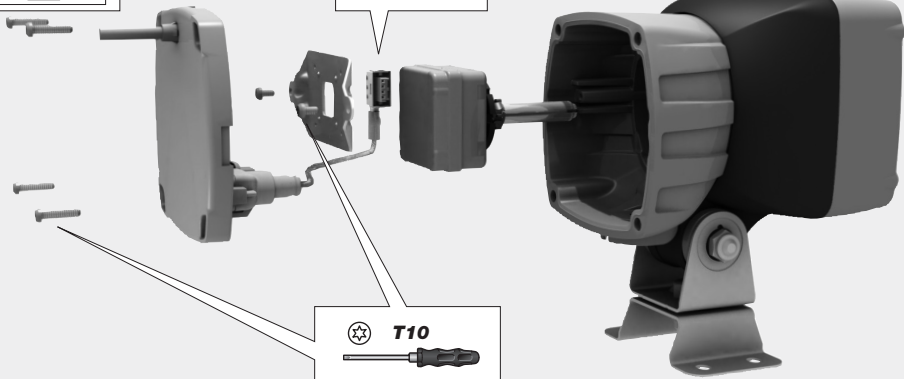

Elektrischer Anschluss
Electrical connection
Branchement électrique

Elektrisk anslutning
Elektrische aansluiting
Conexión eléctrica

Collegamento elettrico
Sähkõliitântä

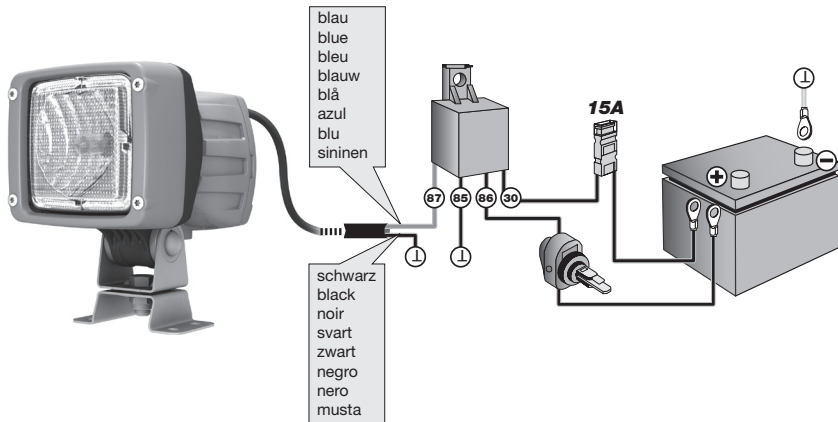

Zubehör
Accessories
Accessoires

Tillbehör
Toebehoren
Accesorios

Accessori
Lisätarvikkeet

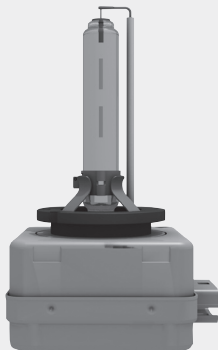

D1S 35W
Hella 8GS 990 332-001



12V
Hella 4RA 003 510-081

24V
Hella 4RA 003 510-091

Hella Fahrzeugteile Austria GmbH

Target Group Agricultural, Construction and Utility Machinery
Target Group Power Sports
A-1100 Wien / Vienna Austria

460 879-17 07/08

