

MONTAGEANLEITUNG

ARBEITSSCHEINWERFER POWERBEAM 2000 / POWERBEAM 3000 / RokLUME 230

INSTALLATION INSTRUCTION

WORK LAMPS POWERBEAM 2000 / POWERBEAM 3000 / RokLUME 230

INSTRUCTIONS DE MONTAGE

PROJECTEUR DE TRAVAIL POWERBEAM 2000 / POWERBEAM 3000 / RokLUME 230

MONTERINGSANVISNING

ARBETSSTRÅLKASTARE POWERBEAM 2000 / POWERBEAM 3000 / RokLUME 230

MONTAGEHANDLEIDING

WERKLAMP POWERBEAM 2000 / POWERBEAM 3000 / RokLUME 230

INSTRUCCIONES DE MONTAJE

FARO DE TRABAJO POWERBEAM 2000 / POWERBEAM 3000 / RokLUME 230

ISTRUZIONI DI MONTAGGIO

FARO DE LAVORO POWERBEAM 2000 / POWERBEAM 3000 / RokLUME 230

ASENNUSOHJE

TYÖVALONEHEITINTÄ POWERBEAM 2000 / POWERBEAM 3000 / RokLUME 230

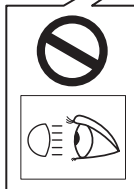
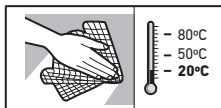

**Scheinwerfer darf nicht abgedeckt werden.
Headlamp must not be covered.
Ne pas recouvrir le projecteur
Strålkastaren får inte täckas över.
Schijnwerper mag niet worden afgedekt.
El faro no deberá taparse.
Non coprire il faro.
Valoa ei saa peittää.**



Produkthaftung

- Es sind die nationalen Anbau-, Einbau- und Betriebsvorschriften zu beachten und einzuhalten.
- Lesen Sie bitte vor Gebrauch des Gerätes alle beigelegten Anleitungen und Sicherheitshinweise.
- Im Zuge von Produktverbesserung behalten wir uns technische und optische Änderungen vor.
- Verwenden Sie nur die Original-ersatzteile bzw. nur Ersatzteile die von HELLA freigegeben sind.
- Bei Fragen oder Einbauproblemen, rufen Sie den HELLA Kundendienst, Großhändler oder wenden Sie sich an Ihre Vertragswerkstatt.

Product liability

- National mounting, fitting and operating regulations must be heeded and kept.
- Please read all the instructions and safety notes included before using the device.
- We reserve the right to make technical and optical modifications within the course of product improvement.
- Only use original spare parts or spare parts approved by HELLA.
- If you have any questions or installation problems, call HELLA customer services, your wholesaler or contact your specialist garage.

Responsabilité produit

- Les prescriptions nationales en matière de montage et de service doivent être observées et respectées.
- Avant d'utiliser l'appareil lire toutes les instructions de montage et de service fournies ainsi que les conseils de sécurité.
- Dans le cadre de l'amélioration continue de nos produits, nous nous réservons le droit de réaliser des modifications sur les plans technique et optique.
- Utilisez uniquement des pièces d'origine ou des pièces de rechange validées par HELLA.
- Pour tous renseignements ou problèmes de montage, contactez le S.A.V. HELLA, votre distributeur ou votre garage lié par contrat.

Produktansvar

- De nationella monterings-, installations- och driftföreskrifterna ska beaktas och följas.
- Läs alla medföljande instruktioner och säkerhetsanvisningar innan du använder apparaten.
- Vi förbehåller oss rätten till tekniska och optiska ändringar som förbättrar produkten.
- Använd endast original reservdelar resp. endast reservdelar som har godkänts av HELLA.
- Om du har frågor eller problem med installationen, ring HELLA kundtjänst, partihandlaren eller vänd dig till din märkesverkstad.

Productaansprakelijkheid

- Men dient de nationale aanbouw-, inbouw- en bedrijfsvoorschriften in acht te nemen en na te leven.
- Lees a.u.b. alvorens het apparaat te gebruiken alle bijgevoegde gebruiksaanwijzingen en veiligheidsinstructies door.
- In het kader van de productverbetering behouden wij ons technische en optische veranderingen voor.
- Gebruik uitsluitend de originele reserveonderdelen, die door Hella vrijgegeven zijn.
- Bij vragen of inbouwproblemen dient u de HELLA klantenservice, de groothandel te bellen of u te richten tot de dealerwerkplaats.

Responsabilidad civil por productos defectuosos

- Tienen que observarse y cumplirse con las prescripciones nacionales sobre construcciones anexas, de montaje y de funcionamiento
- Rogamos que antes de usar el aparato lean todas las instrucciones y advertencias sobre la seguridad adjuntas.
- En aras de la mejora de los productos, nos reservamos el derecho de hacer modificaciones técnicas y ópticas.
- Use sólo recambios originales o bien sólo recambios autorizados por HELLA.
- Si tiene preguntas que hacer nos o dificultades en el montaje, llame al Servicio de Atención al Cliente de HELLA, a los mayoristas o diríjase a su taller concesionario.

Responsabilità per il prodotto

- Si devono rispettare tutte le normative nazionali di attacco, montaggio e funzionamento.
- Prima di usare l'apparecchio, legga per favore tutte le istruzioni e le avvertenze di sicurezza allegate.
- Nell'ambito del perfezionamento del prodotto, ci riserviamo modifiche tecniche ed estetiche.
- Utilizzare solo pezzi di ricambio originali risp. pezzi autorizzati dalla HELLA.
- In caso di domande o problemi di montaggio, chiami il servizio di assistenza dei clienti della HELLA, il rivenditore o si rivolga alla Sua officina autorizzata.

Tuotevastuu

- Kansalliset asennus- ja käyttöohjeet on huomioitava ja niitä on noudatettava.
- Lue ennen laitteen käyttöä kaikki oheistetut käyttö- sekä turvaohjeet.
- Jatkuvasta tuotekehittelystä johtuen pidätämme oikeuden teknisiin ja optisiin muutoksiin.
- Käytä vain alkuperäisiä tai HELLA hyväksymiä varaosia.
- Jos Sinulla on kysymyksiä tai asennusongelmia, soita HELLA-asiakaspalveluun, tukkukauppiaille tai käänny sopimuskorjaamon puoleen.

DE Technische Änderungen vorbehalten

EN Subject to alteration without notice

FR Sous réserve de modifications techniques

SV Vi reserverar oss för tekniska ändringar

NL Technische wijzigingen voorbehouden

ES Reservadas modificaciones técnicas

IT Con riserva di modifiche tecniche

FI Oikeus teknisiin muutoksiin pidätetään

Zeichenerklärung
Explanation symbols
Explication des symboles

Symbolförklaring
Legenda
Aclaración de símbolos

Legenda
Piirroksen selitys



- (DE)** Richtig
- (EN)** Correct
- (FR)** Correct
- (SV)** Rätt
- (NL)** Goed
- (ES)** Correcto
- (IT)** Giusto
- (FI)** Oikein



- (DE)** Falsch
- (EN)** Incorrect
- (FR)** Incorrect
- (SV)** Fel
- (NL)** Fout
- (ES)** Erróneo
- (IT)** Sbagliato
- (FI)** Väärin



- (DE)** Positionspfeil
- (EN)** Location/Position Arrow
- (FR)** Flèche de Position
- (SV)** Positionpil
- (NL)** Lokatie/Positie pijl
- (ES)** Flecha de posición
- (IT)** Freccia di posizione
- (FI)** Paikannusnuoli



- (DE)** Bewegungspfeil
- (EN)** Movement Arrow
- (FR)** Flèche indiquant sens du mouvement
- (SV)** Rörelsepil
- (NL)** Richtingspijl
- (ES)** Flecha de movimiento
- (IT)** Freccia di movimento
- (FI)** Liikesuuntanuoli



- (DE)** Achtung
- (EN)** Warning
- (FR)** Attention
- (SV)** Varning
- (NL)** Let op
- (ES)** Atención
- (IT)** Attenzione
- (FI)** Huomio



- (DE)** Abklemmen
- (EN)** Disconnect
- (FR)** Déconnecter
- (SV)** Koppla los
- (NL)** Demonteren
- (ES)** Desconectar
- (IT)** Staccare
- (FI)** Irrota



- (DE)** Verbinden
- (EN)** Connect
- (FR)** Connecter
- (SV)** Anslut
- (NL)** In elkaar
- (ES)** Conectar
- (IT)** Collegare
- (FI)** Yhdistä



- (DE)** Siehe
- (EN)** Look/See
- (FR)** Voir
- (SV)** Se
- (NL)** Kijkken naar
- (ES)** Ver
- (IT)** Vedere
- (FI)** Katso

Lieferumfang
Scope of delivery
Fourniture

Leveransomfattning
Leveringsomvang
Alcance de suministro

Contenuto della confezione
Toimituksen sisältö

POWERBEAM 2000: 1GA 996 189-XXX

POWERBEAM 3000 / RokLUME 230: 1GA 996 192-XXX



Zubehör
Accessories
Accessories

Tillbehör
Toebehoren
Accessorios

Accessori
Lisätarvikkeet



6EH 007 946-001



3A: 8JS 711 683-821
5A: 8JS 711 684-821
7,5A: 8JS 711 685-821

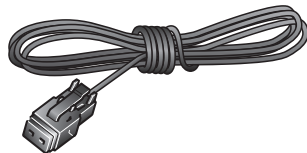

8KB 990 299-011



8JD 005 235-801



8KW 744 697-003

Benötigte Montagewerkzeuge
Installation tools required
Outils de montage requis

Nödvändiga monteringsverktyg
Benodigde montagewerktuigen
Herramientas de montaje necesarias

Attrezzi necessari per il montaggio
Tarvittavat asennustyökalut

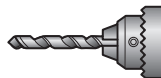

Ø 10,5 mm

Ø 12,5 mm



10, 13, 16, 17, 18, 19

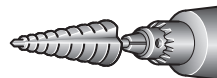
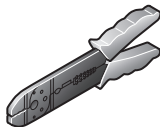
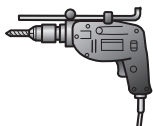
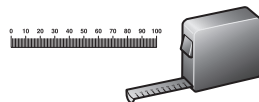

Montage
Mounting
Montage Général

Montering
Montage
Montaje

Montaggio
Asennus

POWERBEAM 2000:

1GA 996 189-XXX

POWERBEAM 3000: RokLUME 230:

1GA 996 192-XXX

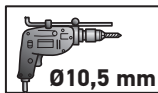
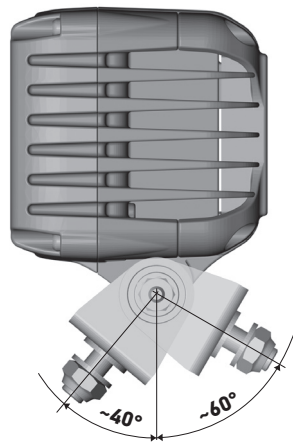
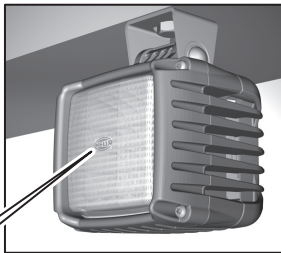

Ø10,5 mm

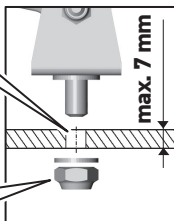

max. 7 mm

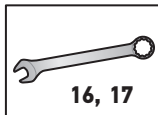

16, 17



POWERBEAM 2000:

POWERBEAM 3000: RokLUME 230:

1GA 996 189-XXX

1GA 996 192-XXX

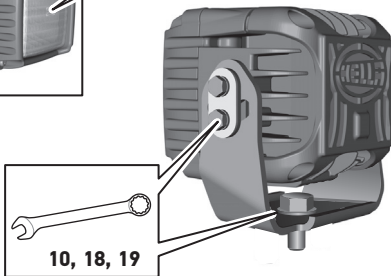
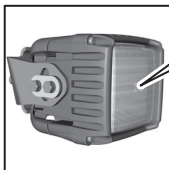
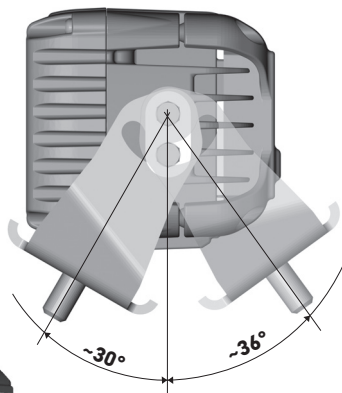
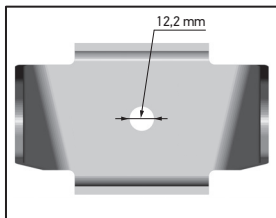
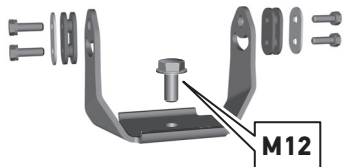

Elektrischer Anschluss
Electrical connection
Branchement électrique

Elektrisk anslutning
Elektrische aansluiting
Conexión eléctrica

Collegamento elettrico
Osaluettelo

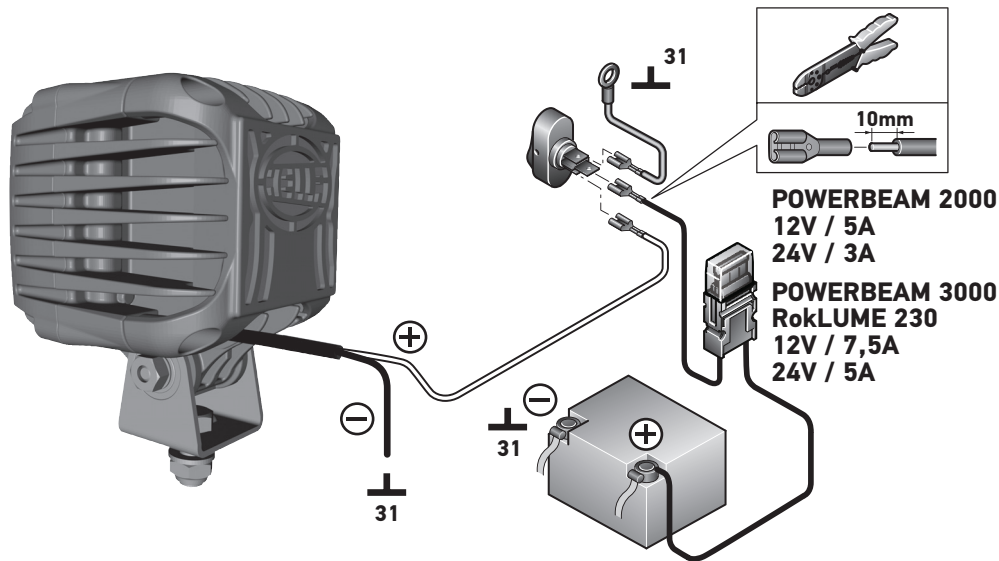

Elektrischer Anschluss
Electrical connection
Branchement électrique

Elektrisk anslutning
Elektrische aansluiting
Conexión eléctrica

Collegamento elettrico
Osaluuttelo

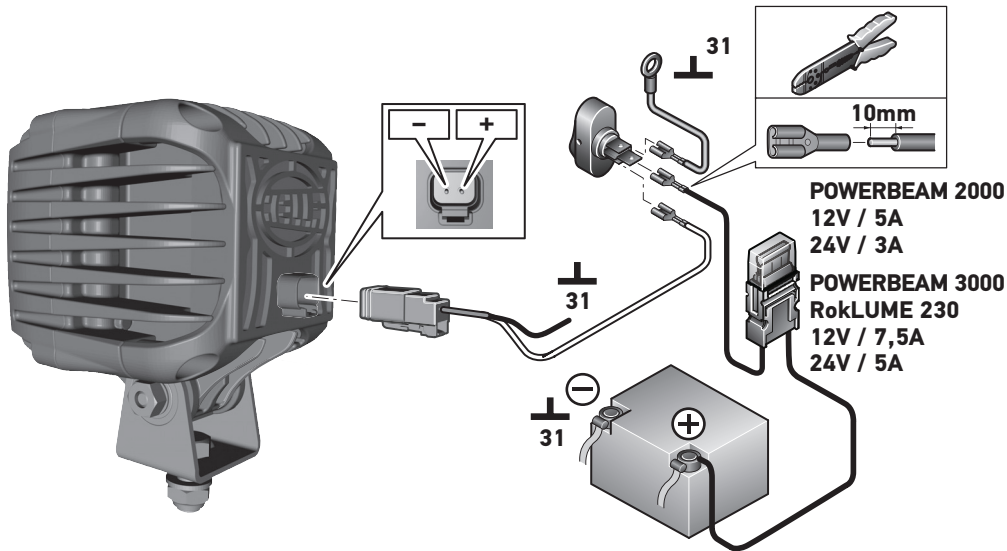

DE	Informationstext	16
EN	Information Text	16
FR	Texte d'information	17
SV	Informationstext	17
NL	Informatie tekst	18
ES	Texto informativo	18
IT	Informazioni	19
FI	Ohjetekstit	19

DE TECHNISCHE DATEN

	Nennspannung	Spannungsbereich	Eingangswerte	Zulässige Umgebungstemperatur	Schutzklasse
POWERBEAM 2000	12 V	9V - 32 V	< 4 A < 45 W	-40° C bis +50° C	IP 6K 9K IP 6K8
	24 V		< 2 A < 43 W		
POWERBEAM 3000	12 V		< 5,5 A < 49 W		
RokLUME 230	24 V		< 2,5 A < 45 W		

Der Betrieb der Leuchte mit Wechselspannung oder getakteter Gleichspannung ist nicht zulässig!

16

EN TECHNICAL DATA

	Nominal voltage	Range of voltage	Input values	Admissible ambient temperature	Class of protection
POWERBEAM 2000	12 V	9V - 32 V	< 4 A < 45 W	-40°C up to +50°C	IP 6K 9K IP 6K8
	24 V		< 2 A < 43 W		
POWERBEAM 3000	12 V		< 5,5 A < 49 W		
RokLUME 230	24 V		< 2,5 A < 45 W		

Operation of the light using alternating voltage or clocked direct voltage is not permitted!

FR DOCUMENT TECHNIQUE

	Tension nominale	Plage de tension	Valeurs d'entrée	Température ambiante admissible	Classe de protection
POWERBEAM 2000	12 V	9V - 32 V	< 4 A < 45 W	-40°C à +50°C	IP 6K 9K IP 6K8
	24 V		< 2 A < 43 W		
POWERBEAM 3000	12 V		< 5,5 A < 49 W		
RokLUME 230	24 V		< 2,5 A < 45 W		

Le fonctionnement du feu avec une tension alternative ou une tension continue cadencée n'est pas admis!

17

SV TEKNISKA DATA

	Märk-spänning	Spän-ningsom-råde	Ingångsvärden	Tillåten omgivning-stemperatur	Skyddsklass
POWERBEAM 2000	12 V	9V - 32 V	< 4 A < 45 W	-40°C upp till +50°C	IP 6K 9K IP 6K8
	24 V		< 2 A < 43 W		
POWERBEAM 3000	12 V		< 5,5 A < 49 W		
RokLUME 230	24 V		< 2,5 A < 45 W		

Lampan får inte användas med växelspanning eller taktad likspänning!

NL TECHNISCHE GEGEVENS

	Nominale spanning	Spanningsbereik	Ingangswaarden	Toegestane omgevingstemperatuur	Beschermklasse
POWERBEAM 2000	12V	9V - 32V	< 4 A < 45 W	-40°C tot +50°C	IP 6K 9K IP 6K8
	24V		< 2 A < 43 W		
POWERBEAM 3000	12V		< 5,5A < 49 W		
RokLUME 230	24V		< 2,5 A < 45 W		

Het gebruik van de lamp met wisselspanning of getacte gelijkspanning is niet toegestaan!

18

ES DATOS TÉCNICOS

	Tensión nominal	Margen de tensión	Valores de entrada	Temperatura ambiente admisible	Clase de protección
POWERBEAM 2000	12V	9V - 32V	< 4 A < 45 W	-40°C hasta +50°C	IP 6K 9K IP 6K8
	24V		< 2 A < 43 W		
POWERBEAM 3000	12V		< 5,5A < 49 W		
RokLUME 230	24V		< 2,5 A < 45 W		

¡No es admisible el funcionamiento de las luces con corriente alterna o corriente continua sincronizada!

IT DATI TECNICI

	Tensione nominale	Intervallo di tensione	Valori di ingresso	Temperatura ambiente ammessa	Categoria di protezione
POWERBEAM 2000	12 V	9V - 32V	< 4 A < 45 W	da -40°C a +50°C	IP 6K 9K IP 6K8
	24 V		< 2 A < 43 W		
POWERBEAM 3000	12 V		< 5,5 A < 49 W		
RokLUME 230	24 V		< 2,5 A < 45 W		

Non è consentito attivare i fanali con tensione alternata o tensione continua ciclica!

FI TEKNISET TIEDOT

	Nimellisjännite	Jännitealue	Tuloarvot	Sallittu ympäristölämpötila	Kotelointiluokka
POWERBEAM 2000	12 V	9V - 32V	< 4 A < 45 W	-40°C ... +50°C	IP 6K 9K IP 6K8
	24 V		< 2 A < 43 W		
POWERBEAM 3000	12 V		< 5,5 A < 49 W		
RokLUME 230	24 V		< 2,5 A < 45 W		

Valoa ei saa käyttää vaihtojännitteellä eikä tahdistetulla tasajännitteellä!

DE Beleuchtungsanlage auf einwandfreie Funktion hin prüfen

EN Check that the lighting system is working perfectly

FR Contrôler le bon fonctionnement de l'installation d'éclairage

SV Kontrollera att ljussystemet fungerar felfritt

NL Controleer of de verlichting goed functioneert

ES Comprobar que el sistema de iluminación funciona impecablemente

IT Controllare la perfetta funzionalità dell'impianto di illuminazione

FI Tarkasta valaistusjärjestelmän toiminta

DE Bei Fragen oder Einbauproblemen, rufen Sie bitte den HELLA Kundendienst, Großhändler an oder wenden Sie sich an Ihre Werkstatt.

EN If you have questions or installation problems, please call the HELLA Service, wholesaler, or turn to your garage.

FR Pour toutes questions ou problèmes de montage, merci de contacter le service après-vente HELLA, votre distributeur ou votre garage.

SV Vid frågor eller monteringsproblem, kontakta Hellas kundtjänst, återförsäljaren eller din verkstad.

NL In geval van vragen of montageproblemen verzoeken wij u contact met de HELLA-klantenservice, de groothandel of uw dealer op te nemen.

ES En caso de dudas o problemas de montaje, por favor, llame al Servicio postventa de Hella o al mayorista, o bien dirijase a su taller.

IT Per qualsiasi domanda o problemi di montaggio si prega di contattare il servizio assistenza o il proprio grossista HELLA oppure di rivolgersi alla propria officina.

FI Jos sinulla on kysymyksiä tai asennusongelmia, soita HELLA-asiakaspalvelulle tai tukkuliikkeelle tai käänny korjaamon puoleen.

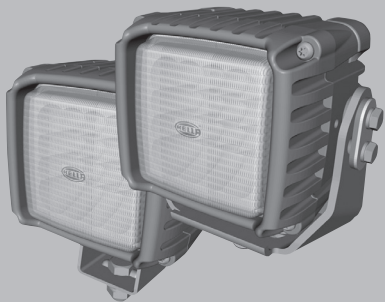

HELLA KGaA Hueck & Co.

Rixbecker Straße 75

59552 Lippstadt /Germany

www.hella.com

© HELLA KGaA Hueck & Co., Lippstadt

460 879-20 /07.15